

The Power in Engineering

TRIDENT

HYDRAULICS & ELECTRONICS



Marine
Hydraulics

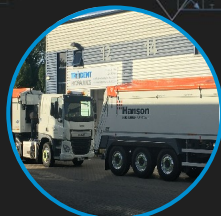

Commercial Hydraulics
Design & Installation



Automation Hydraulic
Systems With PLC Control



Mobile
Electronics & Hydraulics



Arboricultural & Agricultural
Hydraulics

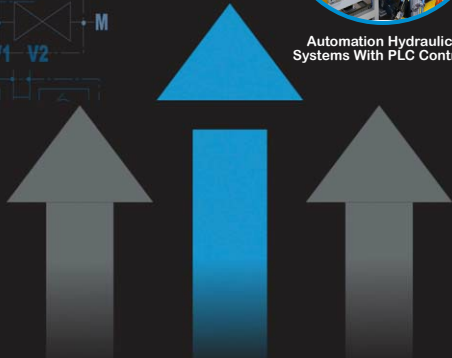

PRODUCT CATALOGUE

PUMP CALCULATIONS

Q = Flow (L/MIN)

V = CC/REV

n = Speed (RPM)

ηv = % Efficiency

P = Pressure (BAR)

B = Back Pressure

H = KW Heat

K = KW

FORMULAE

POWER CONSUMPTION

$$\frac{Q \times P}{600 \eta} = \text{KW}$$

CONVERT CC/REV TO FLOW

$$\frac{V \times n}{1000} = Q$$

REQUIRED SHAFT TORQUE

$$\frac{V \times P}{20 \Pi \eta} \sim \frac{V \times P}{62.8 \eta} = \text{Nm}$$

FORCE

$$\frac{K \times 600}{\pi} = P$$

$$\frac{B \times Q}{\pi} = H$$

$$\frac{Q}{n \times 1000} = V$$

ENTER PUMP DATA

GROUP/CC _____

PORTS SIZES INLET _____

PORTS SIZES OUTLET _____

PORT CONNECTION TYPE _____

SHAFT TYPE _____

FLANGE TYPE _____

ROTATION _____

PARAMETERS _____

OPERATING CONDITIONS _____

Just fill out the above to help identify and size your pump! Scan or fax (including your contact details) to the Trident team!

Formula to calculate gear pump displacement when the part number is no longer visible!
 Example gear and formula set up shown below:

$$Q = \frac{\pi}{2} \times b \times (da^2 - a^2) \quad Q = \frac{\pi}{2} \times 1.614 \times (5.039^2 - 4.206^2) = 19.52\text{cc/rev}$$

Q = Displacement cm^3/rev .

b = Gear Width cm .(see photo 1)

da = Gear tip diameter cm .(see photo 2)

a = Gear Centres (when meshed) cm .(see photo 3)



Photo 1 – shows gear width 1.614cm

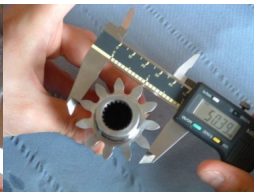

Photo 2 – shows tip diameter 5.039cm

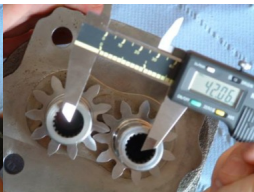

Photo 3 - shows gear centres 4.206cm

CONTENTS.....	2
INTRODUCTION.....	3
BESPOKE POWER PACKS.....	4

SALAMI



MONOBLOCK TYPE.....	5
SECTIONAL TYPE.....	7
DIRECTIONAL CONTROL VALVES.....	9
LOAD SENSING VALVES.....	10
GEAR PUMPS & MOTORS.....	11-16

FLUID PRESS

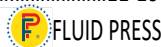

OVER CENTRE VALVES, REGENERATIVE CIRCUITS & HICs.....	17-25
FLOW DIVIDERS, VALVES & INVERTERS.....	23
VALVES & MANIFOLD.....	24

HPT



PISTON PUMPS & MOTORS.....	26-31
----------------------------	-------

ARGO HYTOS



CETOP VALVES.....	32-37
FILTERS.....	38-40

SETTIMA



CONTINUUM PUMP.....	41-42
SFO PUMP.....	43
SMAPI PUMP.....	44
SMT/SMAT SCREW PUMPS.....	45-46
VOLUMETER.....	47
SLN PUMP.....	48

TRIDENT HYDRAULICS

TRIDENT HOSE & MECHANICAL.....	49
TRIDENT POWERED SOLUTIONS.....	50
TRIDENT PUMP & MOTOR REPAIR TEST CENTRE.....	51
CONTROL PANELS.....	52
MANIFOLD DESIGN.....	53
AUTOMATION DESIGN.....	54



Trident Hydraulics & Electronics take hydraulics to another level, we are leaders in the design, manufacture and supply of hydraulic systems and circuits. By using programmable relays & PLC's our packs can perform a multitude of functions. Our in-house design engineers pride themselves on always moving forward with system design using state of the art 3D Solidworks CAD & FEA software to develop high spec hydraulic systems and controls.

Using hydraulic and electronic controls, Trident can take your company forward with full backup taking projects all the way through from concept to completion and installation, working hand in hand to achieve the solutions and products you require.

Our bespoke manifold blocks are designed and manufactured in house by 'Trident Machining' this enables a rapid turn around and ensures our exacting standards are adhered to. All our valves and hydraulic systems are assembled by our trained and experienced technicians ensuring the high quality you would expect.

Trident is approved to ISO 9001; therefore all our customers can be assured of the highest quality implicit in the granting of such an approval. Trident believes that quality is assured during the manufacture process by the correct selection of machine and cutting tools in association with pre manufacture planning. Trident works with both large and small companies from a wide variety of different industries. and understand the need for client confidentiality.



The British Fluid Power
Distributors Association
MEMBER





**Carillion Rail 55Kw Hydraulic
Power Pack with 110v
Generator**



**Dual 35Kw Hydraulic
Power Pack for
Mobile Milling Head**



**Mobile Power Pack for
MOD Portable Airport Landing Strip**



**Hose Test Rig for Oil and Gas
Offshore Industry**

VDM6

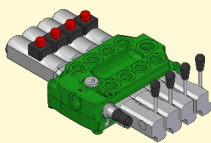

- cast-iron monoblock construction.
- parallel circuit, load check valve protection on down-stream of the pressure "P" line.
- tandem circuit, only the first working section.
- I.c.v. protection + I.c.v. protection on down-stream of the "P" line.
- possibility of power beyond.
- spool construction in steel, hardened and nichel-plated to obtain a higher surface hardness and a better corrosion resistance.
- several types of spool: double, single acting, spool motor, float position, regenerative position etc.
- available spool with overcentre valve built-in, available spool with hydraulic kick-out built-in.
- minimum tolerance between the spools and the body to obtain a minimum internal leakage.
- interchangeability of all the spools.
- several spool control devices and spool positioning devices.

VDM6A

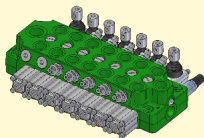

- cast-iron monoblock construction.
- parallel circuit, load check valve protection on each section.
- possibility of power beyond configuration.
- spool construction in steel, hardened and chromium-plated to obtain a higher surface hardness and a better corrosion resistance.
- several types of spool: double, single acting, spool motor, float position, regenerative position etc.
- available spool with overcentre valve built-in, available spool with hydraulic kick-out built-in.
- minimum tolerance between the spools and the body to obtain a minimum internal leakage.
- interchangeability of all the spools.
- possibility of auxiliary valve either on port A or B or on both.
- several spool control devices and spool positioning devices.

VDM09

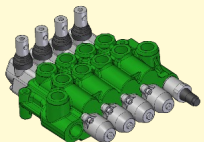

- cast-iron monoblock construction.
- parallel circuit, load check valve protection on down-stream of the pressure "P" line.
- possibility of power beyond.
- spool construction in steel, hardened and nichel-plated to obtain a higher surface hardness and a better corrosion resistance.
- types of spool: double, single acting, spool motor, float position, regenerative position etc.
- available spool with overcentre valve built-in, available spool with hydraulic kick-out built-in.
- minimum tolerance between the spools and the body to obtain a minimum internal leakage.
- several spool control devices and spool positioning devices.

VDM8

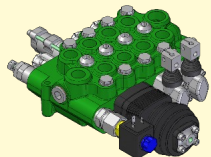

- cast-iron monoblock construction.
- parallel circuit, load check valve protection on each section.
- possibility of power beyond configuration.
- spool construction in steel, hardened and chromium-plated to obtain a higher surface hardness and a better corrosion resistance.
- several types of spool: double, single acting, spool motor, float position, regenerative position etc.
- available spool with overcentre valve built-in, available spool with hydraulic kick-out built-in.
- minimum tolerance between the spools and the body to obtain a minimum internal leakage.
- interchangeability of all the spools.
- possibility of auxiliary valve either on port A or B or on both.
- several spool control devices and spool positioning devices.

Main characteristics

TYPE	NOMINAL FLOW (l/min - US gpm)	OPERATING PRESSURE (bar - psi)	NR. OF SECTION	CIRCUIT*	SECTION DISTANCE (mm - in)	STANDARD THREADS (referred to ports)			
						BSP (ISO 228/1)	UN-UNF (ISO 11926-1)	METRIC (ISO 262)	METRIC (ISO 6149-1)
VDM6	45 - 12	315 - 4600	1 + 7	P/T ⁽¹⁾	32 - 1,26	G3/8	SAE 8	M18x1.5	M18x1.5
VDM6A	45 - 12	370 - 5400	1 + 7	P	36 - 1,42	G3/8 ⁽²⁾	SAE 8	M18x1.5	M18x1.5
VDM09	75 - 20	280 - 4000	1 + 6	P	38 - 1,50	G1/2	SAE 10	M22x1.5	M22x1.5
VDM8	75 - 20	315 - 4600	1 + 7 ⁽³⁾	P	40 - 1,57	G1/2	SAE 10	M22x1.5	M22x1.5

(*) P=parallel / S=series / T=tandem

(1) Tandem circuit available only on the first working section of the 4, 5

and 6 working sections monoblocks.

(2) G1/2 ports also available, for other size ports please get in touch

Configuration

	VDM6	VDM6A	VDM09	VDM8
CONTROLS				
Mechanical	•	•	•	•
Hydraulic	•	•	•	•
Pneumatic	•	•	•	•
Direct electric	•	•		•
Electro-hydraulic		•		•
Electro-pneumatic	•	•	•	•
AUXILIARY VALVES				
On ports		•		•
Unloader valve	•	•		•

VD6A

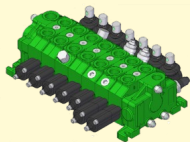

- cast-iron made (inlet section, working section, outlet section).
- parallel circuit, load check valve protection on each section.
- series circuit, load check valve protection on each section (possibility of 2nd load check valve on series line)
- tandem circuit, load check valve protection on each section.
- inlet with adjustable pressure compensated priority flow valve built-in available.
- possibility of power beyond configuration and possibility of closed centre.
- spool construction in steel, hardened and nichel-plated to obtain a higher surface hardness and a better corrosion resistance.
- several types of spool: double, single acting, spool motor, float position, regenerative position etc.
- available spool with overcentre valve built-in, available spool with hydraulic kick-out built-in.
- minimum tolerance between the spools and the body to obtain a minimum internal leakage.
- interchangeability of all the spools.
- several spool positioning devices.

VD8A

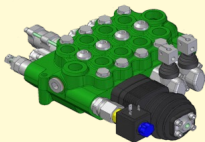

- cast-iron made (inlet section, working section, outlet section).
- parallel circuit, load check valve protection on each section.
- series circuit, load check valve protection on each section (possibility of 2nd load check valve on series line)
- tandem circuit, load check valve protection on each section.
- working section with pressure compensated priority flow valve built-in available.
- possibility of power beyond configuration and possibility of closed centre.
- spool construction in steel, hardened and nichel-plated to obtain a higher surface hardness and a better corrosion resistance.
- several types of spool: double, single acting, spool motor, float position, regenerative position etc.
- available spool with overcentre valve built-in, available spool with hydraulic kick-out built-in.
- minimum tolerance between the spools and the body to obtain a minimum internal leakage.
- interchangeability of all the spools.
- several spool positioning devices.

VD10A

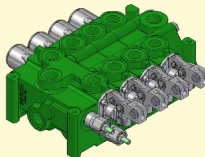

- cast-iron made (inlet plus working module, single working module, outlet module).
- parallel circuit, load check valve protection on each section.
- series circuit, load check valve protection on each section. (series line realised inside of the spool with dedicated lcv.).
- tandem circuit, load check valve protection on each section.
- possibility of power beyond configuration.
- spool construction in steel, nickel plated to obtain a higher surface hardness and a better corrosion resistance.
- several types of spool: double, single acting, spool motor, float position etc.
- available spool with hydraulic kick-out built-in.
- minimum tolerance between the spools and the body to obtain a minimum internal leakage.
- interchangeability of all the spools.
- several spool positioning devices.

VD12A

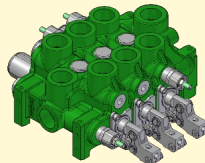

- cast-iron made (inlet module or inlet plus working module, single working module, outlet module).
- parallel circuit, load check valve protection on each section.
- series circuit, load check valve protection on each section. (series line realised inside of the spool with dedicated lcv.).
- tandem circuit, load check valve protection on each section.
- possibility of power beyond configuration.
- spool construction in steel, nickel plated to obtain a higher surface hardness and a better corrosion resistance.
- several types of spool: double, single acting, spool motor, float position etc.
- available spool with overcentre valve built-in, available spool with hydraulic kick-out built-in.
- minimum tolerance between the spools and the body to obtain a minimum internal leakage.
- interchangeability of all the spools.
- several spool positioning devices.

Main characteristics

TYPE	NOMINAL FLOW (l/min - US gpm)	OPERATING PRESSURE (bar - psi)	NR. OF SECTIONS	CIRCUIT*	SECTION DISTANCE (mm - in)	STANDARD THREADS (referred to ports)			
						BSP (ISO 228/1)	UN-UNF (ISO 11926-1)	METRIC (ISO 262)	METRIC (ISO 6149-1)
VD6A	45 - 12	315 - 4600	1 + 8 ⁽¹⁾	P/S/T	35.5 - 1.40	G3/8	SAE 8	M18x1.5	M18x1.5
VD8A	75 - 20	315 - 4600	1 + 8 ⁽¹⁾	P/S/T	40 - 1.57	G1/2 G3/4 ⁽²⁾	SAE 10	M22x1.5	M22x1.5
VD10A	115 - 32	280 - 4000	1 + 8 ⁽¹⁾	P/S/T	46 - 1.81	G3/4	SAE 12		
VD12A	170 - 45	280 - 4000	1 + 8 ⁽¹⁾	P/S/T	52 - 2.05	G1	SAE 16		

(*) P=parallel / S=series / T=tandem

(1) For more working sections, please contact our sales department.

Configuration

	VD6A	VD8A	VD10A	VD12A
Controls				
Mechanical	•	•	•	•
Hydraulic	•	•	•	•
Pneumatic	•	•	•	•
Direct electric	•	•		
Electro-hydraulic	•	•	•	•
Elettro-pneumatic	•	•	•	•
Auxiliary valves				
On ports	•	•	•	•
Unloader valve	•	•	•	•
Intermediate sections				
Mid return manifold	•	•	•	•
With secondary inlet	•	•	•	•
With service relief valve	•	•	•	•
With flow control	•	•		
With priority flow valve			•	•

VDM071/VDM091/VD6A

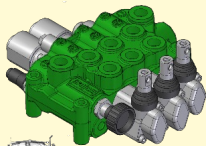

- especially designed for tractor.
- cast-iron monoblock construction available with 3 and/or 4 spools.
- tandem circuit first working section with load check valve protection on down-stream of the "P" line and priority flow valve to adjust the flow required(only on the 4 sections monoblock).
- parallel circuit, load check valve protection on down-stream of the pressure "P" line.
- possibility of power beyond.
- spool construction in steel, hardened and nichel-plated to obtain a higher surface hardness and a better corrosion resistance.
- several types of spool: double, single acting, spool motor, float position.
- available spool with hydraulic kick-out built-in.
- minimum tolerance between the spools and the body to obtain a minimum internal leakage.
- possibility of auxiliary valve only on B port, included valve to shift from double acting to single acting spool.
- load check valve mechanical operated on A port available.
- several spool control devices and spool positioning devices.

VDM07

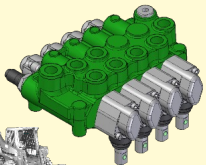

- especially designed for truck crane stabilisers.
- cast-iron monoblock construction.
- parallel circuit, load check valve protection on down-stream of the pressure "P" line.
- possibility of power beyond.
- spool construction in steel, hardened and nichel-plated to obtain a higher surface hardness and a better corrosion resistance.
- types of spool: double, single acting, spool motor, float position, regenerative position etc.
- available spool with overcentre valve built-in, available spool with hydraulic kick-out built-in.
- minimum tolerance between the spools and the body to obtain a minimum internal leakage.
- possibility of auxiliary valve on B port or relief valve on neutral line that can unload both the ports.
- several spool control devices and spool positioning devices.

VD8A

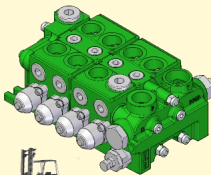

- especially designed for Diesel engine fork-lift truck
- cast-iron made, inlet module with priority flow valve adjustable by a pressure signal.
- priority flow available to supply a power steering unit.
- two double working modules.
- load check valve protection on down-stream of the pressure "P" line, on every sections.
- overcentre valve built-into the spool to control the tilt function.
- spool construction in steel, hardened and nichel-plated to obtain a higher surface hardness and a better corrosion resistance.
- double and single acting spool circuit.
- minimum tolerance between the spools and the body to obtain a minimum internal leakage.
- possibility of auxiliary valve only on B port.
- several spool control devices and spool positioning devices.

VD4E100

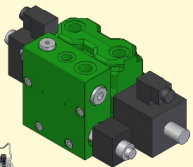

- especially designed for multiutility vehicles.
- 4/3 Directional Control Valve
- 5-chambers model with good spool guidance
- Parallel connection (adding more working sections)
- Cast-iron body (inlet/outlet and working sections)
- Inlet port with Venting Valve
- Main Relief Valve (direct operated or pilot operated)
- Check valve on inlet port (optional)
- Auxiliary inlet port (P2) for second pump with combining flows (optional)
- Direct operation with wet pin solenoid
- Coils can be changed without having to open the pressure-tight chamber
- Manual override, optional
- Open Centre and Closed Centre spool types

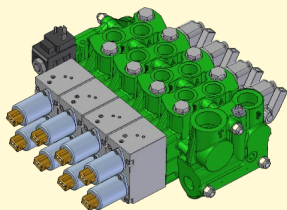
VDP08

- load sensing directional control valve.
- made on cast-iron(inlet section, working section, end section).
- available with inlet module for fixed or variable displacement pump.
- inlet module with pressure compensator built-in.
- working modules with pressure compensator built-in.
- possibility of venting valve.
- spool construction in steel, hardened and chromium-plated to obtain a higher surface hardness and a better corrosion resistance.
- several types of spool: double, single acting, spool motor, float position etc.
- minimum tolerance between the spools and the body to obtain a minimum internal leakage.
- interchangeability of all the spools.
- possibility of auxiliary valve either on port A or B or on both.
- possibility of pressure relief valve on the LS line coming from the ports.
- handle control also with friction to lock the spool in every intermediate position.
- pneumatic proportional control available.
- hydraulic proportional control available.
- closed loop electronic-hydraulic control available (picture beside).
- on-off electro-hydraulic control available 12 or 24 Vdc.

Main characteristics

TYPE	NOMINAL FLOW		OPERATING PRESSURE (bar - psi)	NR. OF SECTION	CIRCUIT*	SECTION DISTANCE (mm - in)	STANDARD THREADS (referred to ports)	
	on inlet (l/min - US gpm)	on ports (l/min - US gpm)					BSP (ISO 228/1)	UN-UNF (ISO 11926-1)
VDP08	130 - 34	95* - 25*	315 - 4600	1 + 8	FDC / VDC	48 - 1,89	G1/2	SAE 10

(*) with compensator

(**) FDC = fixed displacement circuit / VDC = variable displacement circuit

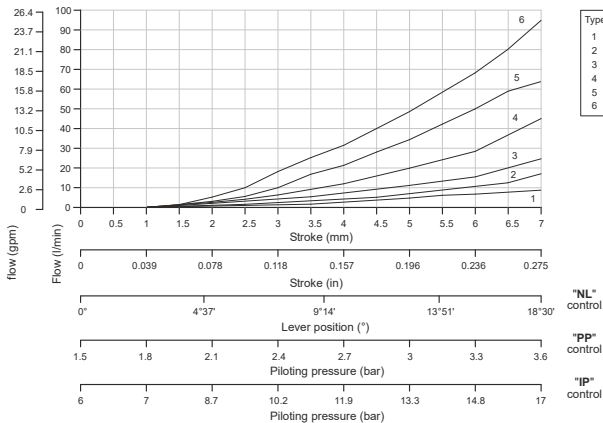
MEETERING CHARACTERISTICS WITH AVAILABLE CONTROLS

 Type
 1
 2
 3
 4
 5
 6

 "NL"
 control

 "PP"
 control

 "IP"
 control

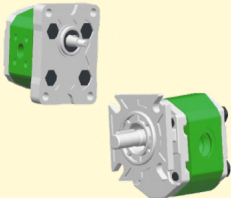
1.5PE



- Gear pumps and motors made with aluminium alloy body, flanges and rear covers
- High volumetric efficiency by innovative design and accurate control of machining tolerances.
- Axial compensation is achieved by using floating bushes that allow high volumetric efficiency throughout the pressure range.
- DU bearings ensure high pressure capability.
- Nitrile seals as standard and viton seals in high temperature range.
- Available with flanges, shafts and ports for the main European, German and SAE standards.
- Assembling on multiple stage pump available.
- All pumps and motors are tested after assembly and run-in to ensure the high standard required by Salamji engineers.

TYPE		0.9*	1.1*	1.6*	2.1	2.6	3.1	3.6	4.2	4.9	5.8	7.5	
Displacement	cm ³ /rev	0.91	1.1	1.5	2.1	2.6	3.1	3.6	4.2	4.9	5.8	7.5	
	cu.in./rev	0.055	0.067	0.091	0.128	0.158	0.189	0.219	0.256	0.299	0.354	0.457	
Working pressure p1	bar	240							250				220
	psi	3480							3600				3190
Intermittent pressure p2	bar	560	270				280				240		
	psi	3770	3900				4060				3480		
Peak pressure p3	bar	280	290				300				260		
	psi	4060	4200				4300				3770		
Max speed	rpm	6000						5000					
Min speed	rpm	700						700					

* Displacements 0.9 - 1.1 - 1.6 are not available as motors

2PE

ALSO AVAILABLE IN CAST IRON

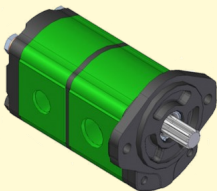

- Gear pumps and motors made with aluminium alloy body and cast iron flanges and rear covers.
- High volumetric efficiency by innovative design and accurate control of machining tolerances.
- Axial compensation is achieved by using floating bushes that allow high volumetric efficiency throughout the pressure range.
- DU bearings ensure high pressure capability.
- 12 teeth integral one-piece gear and shaft.
- Double shaft seals.
- Nitrile seals as standard and viton seals in high temperature range.
- Available with flanges, shafts and ports for the main European, German and SAE standards.
- Outrigger bearing available.
- Available with several rear covers with valves built-in.
- Assembling on multiple stage pump available on both 2PB and 2PE types.
- Extremely compact design on the multiple assembling pump for the 2PE type.
- All pumps and motors are tested after assembly and run-in to ensure the high standard required by Salamji engineers.

TYPE		3.2*	4.5	6.2	8.3	11.3	13.8	16	19	22.5	26
Displacement	cm ³ /rev	3.2	4.6	6.5	8.2	11.5	13.8	16.6	19.4	22.9	25.8
	cu.in./rev	0.19	0.27	0.40	0.50	0.68	0.84	1.01	1.15	1.37	1.58
Working pressure p1	bar	250						220		200	180
	psi	3600						3140		2900	2600
Intermittent pressure p2	bar	280						240		220	200
	psi	4000						3450		3140	2900
Peak pressure p3	bar	300						260		240	220
	psi	4300						3750		3450	3140
Max speed	rpm	4000				3500		3000		2750	2500
Min speed	rpm	600				500		400		400	300

* Available only as rear pump

2PZ

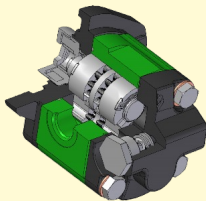

- Gear pumps made with aluminium alloy body and cast iron flanges and rear covers
- **12 teeth double gear staggered assembling construction, to double the flow pulsations in order to reduce the instantaneous flow amplitude, that is the noise level generator.**
- High volumetric efficiency by innovative design and accurate control of machining tolerances.
- Axial compensation is achieved by using floating bushes that allow high volumetric efficiency throughout the pressure range.
- DU bearings ensure high pressure capability.
- Double shaft seals.
- Nitrile seals as standard and viton seals in high temperature range.
- Available with flanges, shafts and ports for the main European, German and SAE standards.
- Outrigger bearing available.
- Available with several rear covers with valves built-in.
- Assembling on multiple stage pump available.
- All pumps and motors are tested after assembly and run-in to ensure the high standard required by Salami engineers.

SALAMI STANDARD CONSTRUCTION



DOUBLE GEAR CONSTRUCTION

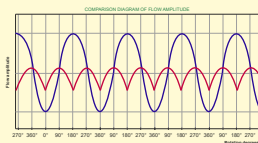

TYPE		5	8	11	14	16	19	22,5*
Displacement	cm ³ /rev (in. ³ /rev)	5 0.30	8 0.49	11 0.66	14 0.85	16	19	22.5 1.37
Working pressure p1	bar psi		220 3140			210 3000	190 2700	180 2600
Intermittent pressure p2	bar psi		250 3600			230 3300	210 3000	200 2900
Peak pressure p3	bar psi		275 3950			250 3600	230 3300	220 3140
Max speed	rpm	4000		3500		3000		2750
Min speed	rpm	600		500			400	

2PW - 2MW (displacements, flanges and shafts are the same available for 2PE -

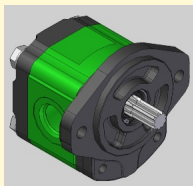

The geometry of the displacement gearing, matched in form by the rotation of the drive shaft, results in the parabolic flow characteristic shown here on the left. In a standard pump, this characteristic is repeated each time a gear tooth meshes. With their dual-flank system, the flow pulsation of 2PW pumps is reduced by 75% – with correspondingly lower excitation of downstream system components – at double the fundamental frequency.

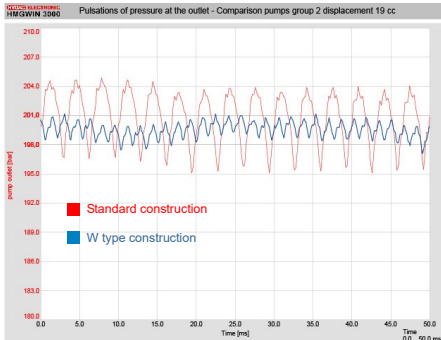

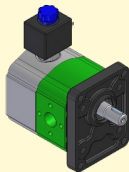
2ME

- Gear motors made with aluminium alloy body and cast iron flanges and rear covers.
- High volumetric efficiency by innovative design and accurate control of machining tolerances.
- Axial compensation is achieved by using floating bushes that allow high volumetric efficiency throughout the pressure range.
- DU bearings ensure high pressure capability.
- 12 teeth integral one-piece gear and shaft.
- Double shaft seals.
- Nitrile seals as standard and viton seals in high temperature range.
- Available with flanges, shafts and ports for the main European, German and SAE standards.
- Outrigger bearing available.
- Available with several rear covers with valves built-in.
- All motors are tested after assembly and run-in to ensure the high standard required by Salami engineers.

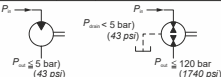
TYPE		4.5	6.2	8.3	10.5	11.3	12.5	13.8	16	19	22.5	26	
Displacement	$\frac{\text{cm}^3}{\text{rev}}$ $\frac{\text{cu.in.}}{\text{rev}}$	4.6 0.27	6.5 0.40	8.2 0.50	10.6 0.65	11.5 0.68	12.7 0.77	13.8 0.84	16.6 1.01	19.4 1.15	22.9 1.37	25.8 1.58	
max. continuous pressure P_1	bar (psi)	250 (3600)								220 (3140)	200 (2900)	180 (2600)	
max. starting pressure P_2		280 (4000)								240 (3450)	220 (3140)	200 (2900)	
min. rotational speed	rpm	600			500				450				
max. rotational speed P_3		4000	3600	3500	3400			3200	3000	2850			
Motor outlet pressure P_{out}	bar (psi)												

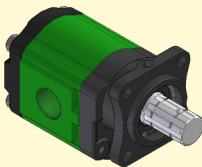
2,5PB - 2,5MB

- Gear pumps and motors made with aluminium alloy body and flanges, cast iron rear covers.
- High volumetric efficiency by innovative design and accurate control of machining tolerances.
- Axial compensation is achieved by using floating bushes that allow high volumetric efficiency throughout the pressure range.
- DU bearings ensure high pressure capability.
- 12 teeth integral one-piece gear and shaft.
- Double shaft seals.
- Nitrile seals as standard and viton seals in high temperature range.
- Available with flanges, shafts and ports for the main European, German and SAE standards.
- Available with several rear covers with valves built-in.
- Extremely compact design on the multiple assembling pump 2.5PB/2.5PB.
- Assembling on multiple stage pump also available in combination with 2PE or 1.5PB types.
- All pumps and motors are tested after assembly and run-in to ensure the high standard required by Salami engineers.

TYPE		5.5*	8.3	11.5	13.8	16	19	22	25	28	32	38	44	
Displacement	$\frac{\text{cm}^3}{\text{rev.}}$ $\frac{\text{cu.in.}}{\text{rev.}}$	5.97 0.36	8.29 0.50	11.76 0.72	14.07 0.86	16 0.97	19.3 1.17	22.2 1.35	25.2 1.53	27.6 1.68	32.4 1.97	38.1 2.32	44.2 2.69	
Working pressure	p_1 bar psi	250 3600										230 3300	200 2900	
Intermittent pressure	p_2 bar psi	280 4000										250 3600	220 3140	190 2700
Peak pressure	p_3 bar psi	300 4300										260 3750	240 3450	210 3000
Max speed		3000										2750	2500	
Min speed	rpm	600					500					400		

* Available only as rear pump

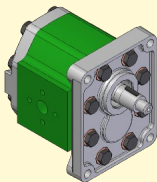
3PE - 3ME

- Gear pumps and motors made with aluminium alloy body, flanges and rear covers.
- High volumetric efficiency by innovative design and accurate control of machining tolerances.
- Axial compensation is achieved by using floating bushes that allow high volumetric efficiency throughout the pressure range.
- DU bearings ensure high pressure capability.
- 12 teeth integral one-piece gear and shaft.
- Double shaft seals.
- Nitrile seals as standard and Viton seals in high temperature range.
- Available with flanges, shafts and ports for the main European, German and SAE standards.
- Outrigger bearing available.
- Available with several rear covers with valves built-in.
- Assembling on multiple stage pump 3PB/3PB available.
- Assembling on multiple stage pump also available in combination with 2PE or 2PB types.
- All pumps and motors are tested after assembly and run-in to ensure the high standard required by Salami engineers.

TYPE		21*	27	33	38	46	55	65	75*
Displacement	cm ³ /rev	20.6	27	33.5	38.7	46.9	54.1	63.1	73.4
	cu.in./rev	1.26	1.65	2.04	2.36	2.86	3.30	3.85	4.48
Working pressure p1	bar		250			245	220	200	180
	psi		3600			3500	3190	2900	2600
Intermittent pressure p2	bar		280			265	240	220	200
	psi		4000			3840	3480	3140	2900
Peak pressure p3	bar		300			275	250	240	220
	psi		4300			3950	3600	3450	3190
Max speed	rpm		3000			2750		2500	
Min speed	rpm	600			500			400	

*Available for quantity, please contact our sales department.

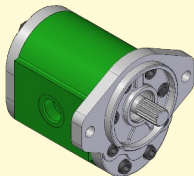
3,5PB

- Gear pumps and motors made with aluminium alloy body, flanges and rear covers.
- High volumetric efficiency by innovative design and accurate control of machining tolerances.
- Axial compensation is achieved by using floating thrust plates that allow high volumetric efficiency throughout the pressure range.
- DU bearings ensure high pressure capability.
- 12 teeth integral one-piece gear and shaft.
- Double shaft seals.
- Nitrile seals as standard and Viton seals in high temperature range.
- Available with flanges, shafts and ports for the main European, German and SAE standards.
- Outrigger bearing available.
- Assembling on multiple stage pump 3,5PB/3,5PB available.
- Assembling on multiple stage pump also available in combination with 2PE, 2PB or 3PB types.
- All pumps and motors are tested after assembly and run-in to ensure the high standard required by Salami engineers.

TYPE		55	64	75	87	98*
Displacement	cm ³ /rev	54.8	63.2	74.7	88	99
	cu.in./rev	3.34	3.85	4.55	5.36	6.03
Working pressure p1	bar		250		210	200
	psi		3600		3000	2900
Intermittent pressure p2	bar		280		230	220
	psi		4000		3300	3140
Peak pressure p3	bar		300		280	250
	psi		4300		4000	3750
Max speed	rpm		2750		2500	2000
Min speed	rpm	400		350		300

*Available for quantity, please contact our sales dept.

PG330 - MG330 Cast Iron Gear Pumps and Motors

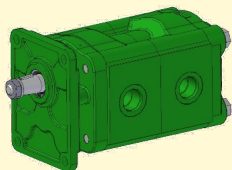
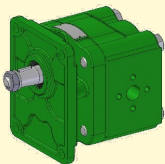

- Gear pumps and motors made in cast iron.
- Construction in 2 pieces: front flange, body and rear cover made in the same piece.
- High volumetric efficiency by innovative design and accurate control of machining tolerances.
- Axial compensation is achieved by using floating thrust plates that allow high volumetric efficiency throughout the pressure range.
- DU bearings ensure high pressure capability.
- 12 teeth integral one-piece gear and shaft.
- Double shaft seals.
- Nitrile seals as standard and Viton seals in high temperature range.
- Available with flanges and shafts for the European and SAE standards.
- Displacements from 23 cm³/rev (1.43 cu.in./rev) to 40 cm³/rev (2.46 cu.in./rev).
- Assembling on double stage pump available.
- All pumps and motors are tested after assembly and run-in to ensure the high standard required by Salami engineers.

TYPE		23	28	34	40
Displacement	cm ³ /rev	23.4	28.6	34.4	40.3
	cu.in./rev	1.43	1.74	2.1	2.46
Working pressure p1	bar	280			260
	psi	4000			3800
Intermittent pressure p2	bar	310			290
	psi	4500			4200
Peak pressure p3	bar	340			320
	psi	5000			4600
Max speed	rpm	3000	2850	2700	
Min speed	rpm	500	450	450	

DEVELOPED RELEASES

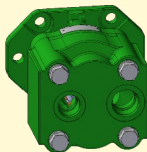

Pump or motor with rear ports

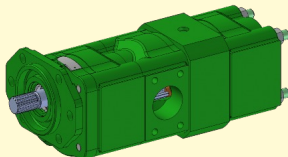

Triple pump construction

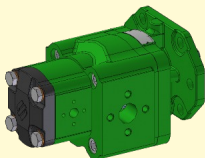

Single pump with 2PE in the back
(available also in common suction)

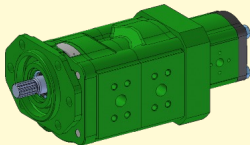

Double pump with 2PE in the back

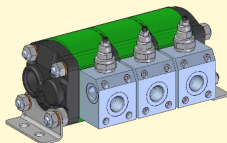
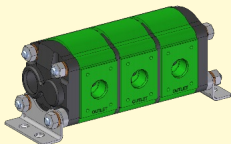
2DRE

The bodies are always pre arranged in order to be assembled with the valve manifold which realises the realignment of cylinders.

In this way dealers can do stock orders of the complete stages, covers, tie rod kits, valve manifolds.

Doing so they can optimise their sales depending on their customers needs.

This can be translated also in an optimisation of the warehouse investment.

- Gear flow dividers made with aluminium alloy body and cast iron flanges and rear covers.
- High volumetric efficiency by innovative design and accurate control of machining tolerances
- Axial compensation is achieved by using floating bushes that allow high volumetric efficiency throughout the pressure range.
- DU bearings ensure high pressure capability.
- 12 teeth integral one-piece gear and shaft.
- Nitrile seals as standard and viton seals in high temperature range.
- Available with ports for the main European, German and SAE standards.
- The bodies are always pre-arranged in order to assemble the cylinder realignment valves.
- Available with common inlet port on the side or on the cast iron covers.
- Assembling on multiple stage up to max. 6 stages.
- Extremely compact design on the multiple assembling pump for the 2PE type.
- All flow dividers are tested after assembly and run-in to ensure the high standard required by Salamir engineers.

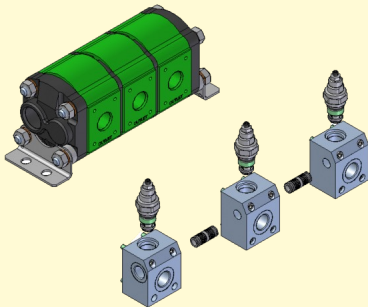

Type	Displacement		Max. outlet pressure				Max. outlet Δp		Speed		Flow per section		Flow per section	
			P ₁	P ₂	P ₁	P ₂	between sections		min.	max.	min.	max.	min.	max.
	cm ³ /rev	cu.in./rev	bar	bar	psi	psi	bar	psi	min ⁻¹		l/min		gpm	
2DRE - 3.2*	3.20	0.19	250	280	3600	4000	50	725	1250	4000	4.21	13.47	1.11	3.55
2DRE - 3.9*	3.90	0.24	250	280	3600	4000	50	725	1250	4000	5.13	16.42	1.35	4.32
2DRE - 4.5	4.60	0.27	250	280	3600	4000	50	725	1250	3900	6.05	18.88	1.59	4.97
2DRE - 6.2	6.50	0.40	250	280	3600	4000	50	725	1250	3750	8.55	25.66	2.25	6.75
2DRE - 8.3	8.20	0.50	250	280	3600	4000	50	725	1200	3600	10.36	31.07	2.73	8.18
2DRE - 10.5*	10.60	0.65	250	280	3600	4000	50	725	1200	3500	13.39	39.05	3.52	10.28
2DRE - 11.3	11.50	0.68	250	280	3600	4000	50	725	1200	3500	14.53	42.37	3.82	11.15
2DRE - 12.5*	12.70	0.77	250	280	3600	4000	50	725	1200	3400	16.04	45.45	4.22	11.96
2DRE - 13.8	13.80	0.84	250	280	3600	4000	50	725	1200	3400	17.43	49.39	4.59	13.00
2DRE - 16	16.60	1.01	250	280	3600	4000	50	725	1100	3200	19.22	55.92	5.06	14.71
2DRE - 19	19.40	1.15	220	240	3150	3450	50	725	1100	3200	22.46	65.35	5.91	17.20
2DRE - 22.5	22.90	1.37	220	240	3150	3450	50	725	1100	3000	26.52	72.32	6.98	19.03
2DRE - 26	25.80	1.58	200	220	2900	3150	50	725	1100	2850	29.87	77.40	7.86	20.37
2DRE - 30*	30.10	1.84	200	220	2900	3150	50	725	1100	2700	34.85	85.55	9.17	22.51



FLUID-PRESS

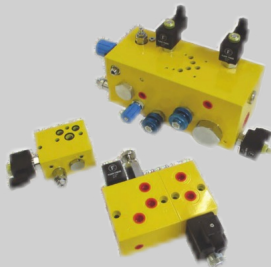

Listening to our customers, we supply the right product at the right price, whilst responding quickly to new requirements and reducing development lead times. We operate in the following markets:

- Agricultural
- Earth Moving Equipment
- Lifting, Access and Transport
- Commercial Vehicles
- Industrial Power Units
- Other Special Applications

Our extensive range of Hydraulic Mechanical and Directional Control Solenoid Screw-in Cartridges, Line Bodied Valves and Integrated Manifold Systems allow us to provide total customer satisfaction by reducing your machine assembly time, improving your customer delivery time and increasing your output. We believe in our strength and consistency of service to our customers ensuring peace of mind and total satisfaction.

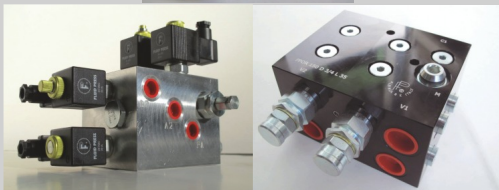

VALVOLE OVERCENTER
Overcenter valves

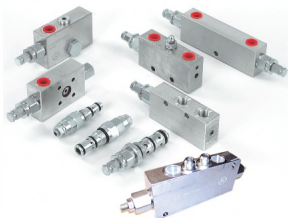

PORTATA NOMINALE
Nominal flow
fino a 300 l/min
up to 300 l/min

PRESSIONE
Pressure
fino a 350 bar
up to 350 bar

SCHEMA IDRAULICO / *Hydraulic scheme*

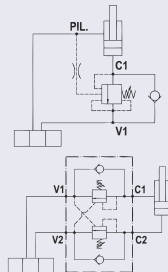

**VALVOLE OVERCENTER
BILANCIATE**
Fully balanced overcenter valves

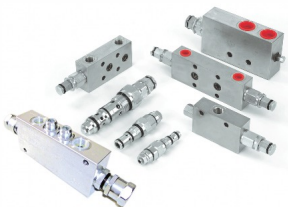

PORTATA NOMINALE
Nominal flow
fino a 300 l/min
up to 300 l/min

PRESSIONE
Pressure
fino a 350 bar
up to 350 bar

SCHEMA IDRAULICO / *Hydraulic scheme*

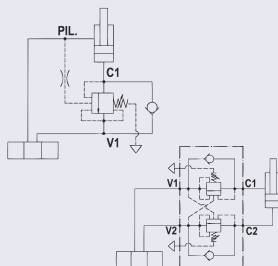

**OVERCENTER PER
CIRCUITI RIGENERATIVI**
Overcenter for regenerative circuits



PORTATA NOMINALE
Nominal flow
fino a 150 l/min
up to 150 l/min

PRESSIONE
Pressure
fino a 350 bar
up to 350 bar

SCHEMA IDRAULICO / *Hydraulic scheme*

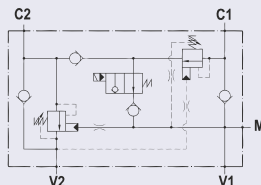

**VALVOLE PER ESCAVATORI
E MOVIMENTO TERRA**

*Valves for excavators and
earth moving equipment*

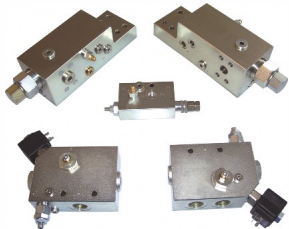

PORTATA NOMINALE

*Nominal flow
da 35 to 500 l/min
from 35 to 500 l/min*

PRESSIONE

*Pressure
fino a 420 bar
up to 420 bar*

SCHEMA IDRAULICO / Hydraulic scheme

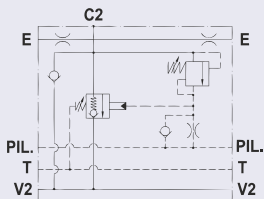

**ELETTROVALVOLE
IN CARTUCCIA**
Solenoid valves

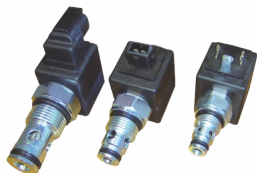

PORTATA NOMINALE

*Nominal flow
da 3 to 140 l/min
from 3 to 140 l/min*

PRESSIONE

*Pressure
fino a 350 bar
up to 350 bar*

SCHEMA IDRAULICO / Hydraulic scheme

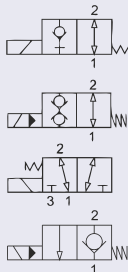

VALVOLE DI MASSIMA
Relief valves

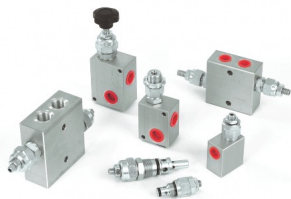

PORTATA NOMINALE

*Nominal flow
da 3 a 200 l/min
from 3 to 200 l/min*

PRESSIONE

*Pressure
fino a 350 bar
up to 350 bar*

SCHEMA IDRAULICO / Hydraulic scheme

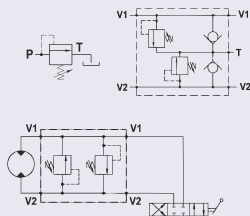

VALVOLE DI SEQUENZA
Sequence valves



PORTATA NOMINALE
Nominal flow
da 15 a 150 l/min
from 15 to 150 l/min

PRESSIONE
Pressure
fino a 350 bar
up to 350 bar

SCHEMA IDRAULICO / Hydraulic scheme

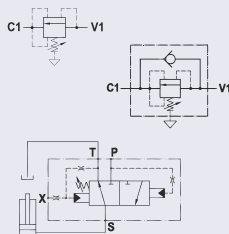

VALVOLE DI RITEGNO
Check valves



PORTATA NOMINALE
Nominal flow
da 12 a 310 l/min
from 12 to 310 l/min

PRESSIONE
Pressure
fino a 350 bar
up to 350 bar

SCHEMA IDRAULICO / Hydraulic scheme

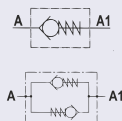

**VALVOLE DI BLOCCO
PILOTATE SEMPLICI**
*Single pilot operated
check valves*



PORTATA NOMINALE
Nominal flow
da 15 a 90 l/min
from 15 to 90 l/min

PRESSIONE
Pressure
fino a 350 bar
up to 350 bar

SCHEMA IDRAULICO / Hydraulic scheme

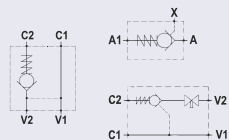

**VALVOLE DI BLOCCO PILOTATE
DOPPIE**

*Double pilot operated
check valves*

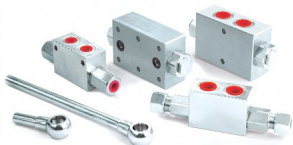

PORTATA NOMINALE
Nominal flow
da 15 a 85 l/min
from 15 to 85 l/min

PRESSIONE
Pressure
fino a 350 bar
up to 350 bar

SCHEMA IDRAULICO / *Hydraulic scheme*

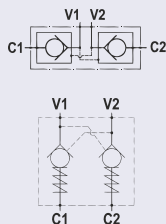

**VALVOLE DI RIDUZIONE
PRESSIONE**

Pressure reducing valve



PORTATA NOMINALE
Nominal flow
da 2 a 60 l/min
from 2 to 60 l/min

PRESSIONE
Pressure
fino a 350 bar
up to 350 bar

SCHEMA IDRAULICO / *Hydraulic scheme*

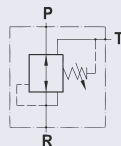

**VALVOLE PER MOTORI
IDRAULICI**

*Valves flangeable on
hydraulic motor*

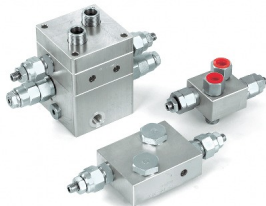

PORTATA NOMINALE
Nominal flow
da 15 a 150 l/min
from 15 to 150 l/min

PRESSIONE
Pressure
fino a 250 bar
up to 250 bar

SCHEMA IDRAULICO / *Hydraulic scheme*

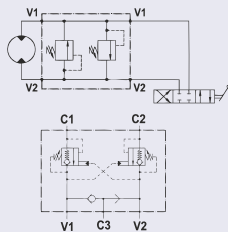

REGOLATORI DI FLUSSO COMPENSATI

*Pressure compensated
flow restrictor valves*

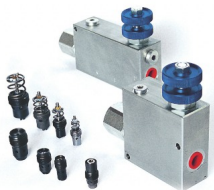

PORTATA NOMINALE
Nominal flow
da 10 a 150 l/min
from 10 to 150 l/min

PRESSIONE
Pressure
fino a 350 bar
up to 350 bar

SCHEMA IDRAULICO / *Hydraulic scheme*

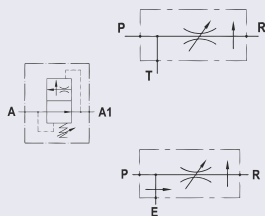

REGOLATORI DI FLUSSO UNIDIREZIONALI BIDIREZIONALI

Needle valves



PORTATA NOMINALE
Nominal flow
da 12 a 310 l/min
from 12 to 310 l/min

PRESSIONE
Pressure
fino a 350 bar
up to 350 bar

SCHEMA IDRAULICO / *Hydraulic scheme*

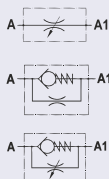

VALVOLE PARACADUTE

Hose break valves



PORTATA NOMINALE
Nominal flow

fino a 200 l/min
up to 200 l/min

PRESSIONE
Pressure
fino a 350 bar
up to 350 bar

SCHEMA IDRAULICO / *Hydraulic scheme*

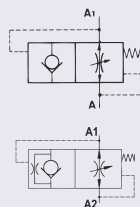

**DIVISORI / RIUNIFICATORI
DI FLUSSO**

Flow divider / combiner



PORTATA NOMINALE

Nominal flow
da 1 a 150 l/min
from 1 to 150 l/min

PRESSIONE

Pressure
fino a 350 bar
up to 350 bar

SCHEMA IDRAULICO / *Hydraulic scheme*



**VALVOLA DI ESCLUSIONE
ALTA-BASSA PRESSIONE**

Two-pump unloading valve



PORTATA NOMINALE

Nominal flow
fino a 150 l/min
up to 150 l/min

PRESSIONE

Pressure
fino a 350 bar
up to 350 bar

SCHEMA IDRAULICO / *Hydraulic scheme*

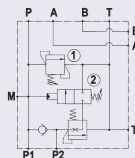

**INVERTITORI AUTOMATICI
SU BASE CETOP**

Cetop sharp automatic inverter



PORTATA NOMINALE

Nominal flow
da 3 a 60 l/min
from 3 to 60 l/min

PRESSIONE

Pressure
fino a 350 bar
up to 350 bar

SCHEMA IDRAULICO / *Hydraulic scheme*

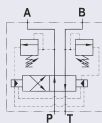

VALVOLE SELETRICI

Shuttle valves



PORTATA NOMINALE

Nominal flow
da 10 a 110 l/min
from 10 to 110 l/min

PRESSIONE

Pressure
fino a 350 bar
up to 350 bar

SCHEMA IDRAULICO / *Hydraulic scheme*

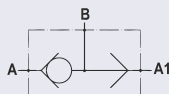

VALVOLE DI FINE CORSA
End run valve



PORTATA NOMINALE
Nominal flow
fino a 45 l/min
up to 45 l/min

PRESSIONE
Pressure
fino a 300 bar
up to 300 bar

SCHEMA IDRAULICO / Hydraulic scheme

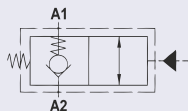

ESCLUSORI PER MANOMETRI
Shut-off pressure gauge valves



PORTATA NOMINALE
Nominal flow
-

PRESSIONE
Pressure
fino a 350 bar
up to 350 bar

SCHEMA IDRAULICO / Hydraulic scheme

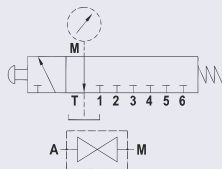

RUBINETTI A SFERA
Ball valves



PORTATA NOMINALE
Nominal flow
da 25 a 200 l/min
from 25 to 200 l/min

PRESSIONE
Pressure
fino a 400 bar
up to 400 bar

SCHEMA IDRAULICO / Hydraulic scheme

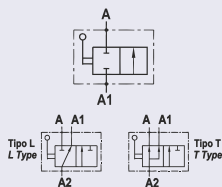

BLOCCHI INTEGRATI MULTIFUNZIONE
Multifunction integrated manifold



SCHEMA IDRAULICO / Hydraulic scheme

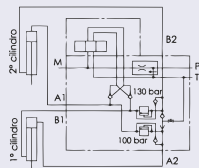

TRIDENT
HYDRAULICS**HPTF 090 & 130 DIN**
five pistons

HPTF 090&130 DIN FIVE PISTONS is a fixed displacement bent-axis pumps for mobile hydraulic applications.

HPTF 090&130 DIN are an ideal pumps for applications that require both a high flow and a high pressure. It is easy mounted directly on the PTO or on a frame bracket via an intermediate shaft.

Further advantages:

- Low noise levels at high maximum speed due to its quality production and design.
- The operation over the entire speed range is smooth.
- Long usage life due to its high demands on material selection such as seals, bearings, ect.
- To avoid leakage from the pump and PTO, there are O-rings on all contact surfaces and double shaft seals for high pressure.
- All pumps are test under extreme testing environment before delivery to custom.
- Easy to change the rotation of pump flow.



TRIDENT
HYDRAULICS**HPTP 084 & 108 DIN**
optimized for injector

HPTP-DIN is a fixed displacement bent-axis pumps for mobile hydraulic applications. The combination of HPTP pump and injector K-Jet2 offers high oil flow.

HPTP 084, 108 DIN optimized pumps for injector is suitable for hydraulic motor operations in closed hydraulic systems with injector K-Jet2 for pressurization of the suction side. For this it gives excellent speed characteristics and high flows. We supply it either with left (L) or right (R) rotation direction.

Further advantages:

- Low noise levels at high maximum speed due to its quality production and design.
- The operation over the entire speed range is smooth.
- Long usage life due to its high demands on material selection such as seals, bearings, ect.
- To avoid leakage from the pump and PTO, there are O-rings on all contact surfaces and double shaft seals for high pressure.
- All pumps are test under extreme testing environment before delivery to custom.
- Easy to change the rotation of pump flow.



TRIDENT
HYDRAULICS**HPTD 56/26 DIN**
dual displacement

HPTD is dual displacement pump is an ideal solution for vehicles that require two different flows.

Dual displacement pumps are the best solution for vehicles with several types of hydraulic equipment such as refuse trucks. Single flow large pump can be a poor solution for these vehicles. For different movement of certain parts of equipment such as fast movement or slow movement. A HPTD pump is most economical solution and high performance. HPTD pumps come with two equal large flows or one large and one small flow.

For variety system solutions:

- Two different circuits
- Parallel working operation

HPTD 56/26 DIN is a twin pump with two separate flows of different size.

HPTD 56/26 is that one flow with 56cm³/rev and the second flow with 26 cm³/rev.

The maximum pressure reaches up to 400 bar per each flow. It can be offer with right(R) or left (L) direction rotation.

Further benefits:

- Low noise levels at high maximum speed due to its quality production and design.
- The operation over the entire speed range is smooth.
- Long usage life due to its high demands



TRIDENT

HYDRAULICS



HPTP-VH 062,092,112&130

HPTP-VH is variable displacement axial piston pump. This pump designed for load sensing systems& directly installation on the trucks power take-off.

For load sensing systems HPTP-VH is one of best solution with a maximum pressure up to 450 bar. Displacement range 62, 92, 112 and 130 cm³/rev. Main applications are forestry cranes, general cargo cranes, suction vehicles refuse collection vehicles. This pump is uniquely feature a slim pump housing which permits direct mounting on PTO.

Further advantages:

- Low noise levels at high maximum speed due to its quality production and design.
- The operation over the entire speed range is smooth.
- Short reaction time when resetting the flow.

Pump controllers description, HPTVH 062,092,112 & 130:

LSNR = Load-Sensing controller with integrated pressure limitation.

NR = Pressure controller, adjustable directly at the pump. The Pressure controller automatically maintains a constant system pressure independent of the required flow.

where differing flow is required or as efficient pressure limitation of the hydraulic system.

/ZL (HPT-VH 062, 092, 112) = Intermediate plate with power controller (torque limitation) "Pressure x Displacement" is held constant. Adjustment range: 25-100% of max. drive torque.

/ZW = Angled intermediate plate (45°) mandatory for mounting controller at pumps with radial inlet and outlet.

/L (HPT-VH 130) = Power controller for HPT-VH 130, Adjustment range: 200-700 Nm

HPTP-VH 062, 092,112& 130		HPT-VH 062	HPT-VH 092	HPT-VH 112	HPT-VH 130
Geometric displacement V _g	cm ³ /rev.	62,4	87,2	110,4	130
Nom. pressure P _{nom}	bar	350	350	350	400
Pressure P _{max}	bar	400	400	400	450
Angle of the swash plate		21,5°	21,5°	21,5°	21,5°
Required inlet pressure (absolute) for open circuit	bar	0,85	0,85	0,85	0,85
Max. permissible drive torque (flange/shaft)	Nm	430	530	900	900
Max. torque for the pump (with power controller)	Nm	430	530	600	700
Max. permissible torque for the thru-shaft, dep. on flange	Nm	100	530	600	700
Max. rev. rating when self priming and max. angle of the swash plate at 1 bar absolute inlet pressure	rpm	2500	2300	2200	2100
Min. rev. rating for permanent running	rpm	500	500	500	500
Required torque at 100 bar	Nm	100	151	184	230
Drive power for 250 bar and 2000 rpm	kW	53	79,5	97,2	120
Mass (weight) complete with controller	kg	24	27	30	30,8
Tare weight torque	Nm	30	35,3	40	40
Inertia moment	kg m ²	0,005	0,008	0,01	0,011
Sound level at 250 bar, 1500 rpm and max. swash plate angle (Measured in a sound measuring room DIN ISO 4412, distance 1 m)	dB(A)	75	75	75	75

TRIDENT

HYDRAULICS



HPTM 012-130 ISO

HPTM 012-130 ISO is bent-axis motors an ideal for mobile hydraulics. These motors are spherical pistons as a type of bent- axis.

HPTM 012-130 SAE is an bent-axis type with spherical pistons. The robust design gives a perfect compact motor with few moving parts, high starting torque and perfect reliability.

The displacement is from 12-130 cm³/rev with a maximum 400 bar. It comes with double tapered roller bearings that allow high shaft loads and results perfect speed performance. This pump meets the market's high demands due to its high flow performance, pressure efficiency and simplest of installation.

Further advantages:

- Low noise levels at high maximum speed due to its quality production and design.
- The operation over the entire speed range is smooth.
- We offer it in many different types of shafts and connections parts.
- Long life with high performance.
- An ideal solution for applications that require high angular accelerations.



TRIDENT
HYDRAULICS**HPTM 025-108 M2**

HPTM 025-108 M2 modern motor with cartridge flange ideal choice for winch-, slewing-, wheel-, & track drives.

HPTM 025-108 M² is an bent-axis type with spherical pistons. The robust design gives a perfect compact motor with few moving parts, high starting torque and perfect reliability.

The displacement is from 25-108 cm³/rev with a maximum 400 bar. It comes with double tapered roller bearings that allow high shaft loads and results perfect speed performance. This pump meets the market's high demands due to its high flow performance, pressure efficiency and simplest of installation

Further advantages:

- Low noise levels at high maximum speed due to its quality production and design.
- The operation over the entire speed range is smooth.
- We offer it in many different types of shafts and connections parts.
- Long life with high performance.
- An ideal solution for applications that require high angular accelerations.



CETOP 3 DIRECTIONAL CONTROL VALVE :

RPE3-06 is a 4 way solenoid operated directional control valve and they come in either single acting (2 position) or double acting (3 position) also there are many different spools to choose from. These valves are used for directing and stopping flow at any point in a hydraulic system using an electrical signal.

The RPE3-06 provides effective control of the hydraulic flow with minimal pressure drop and high reliability. All valves come with a manual override as standard.

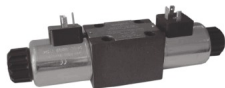
ARGO
HYTOS

 Coil voltage Options
 12 V DC 24 V DC
 110 V DC 230 V DC

SPOOL TYPES	MAX FLOW (L/MIN)	MAX PRESSURE (BAR)
RPE3-062*...	80	350
RPE3-062 C...	80	350
RPE3-062 J...	80	350
RPE3-063*...	80	350
RPE3-063 C...	80	350

Type	Symbol	Crossover	Type	Symbol	Cross
Z11			Z51		
C11			Z71		
H11			Z81		
P11			Z91		
Y11			R31		
L21			H51		
B11			F51		
Y41			Z11		
Z21			X11		
C41			C11		
F11			H11		
R11			K11		
R21			N11		
A51			F11		
P51			X25		
Y51			J15		
C51			J75		

CETOP 3 PRESSURE RELIEF VALVE :

VPP2-04 is a pressure relief valve cartridge that can be fitted to a CETOP 3

Body or inline threaded body.



Pressure Range Options

- Up to 25 bar*
- Up to 63 bar*
- Up to 100 bar*
- Up to 160 bar*
- Up to 250 bar*
- Up to 320 bar*

BODY TYPES	MAX FLOW (L/MIN)	MAX PRESSURE (BAR)
MA / MB / MP	40	320
MC / MD	40	320
RA	40	320
RB	40	320

Functional Symbols

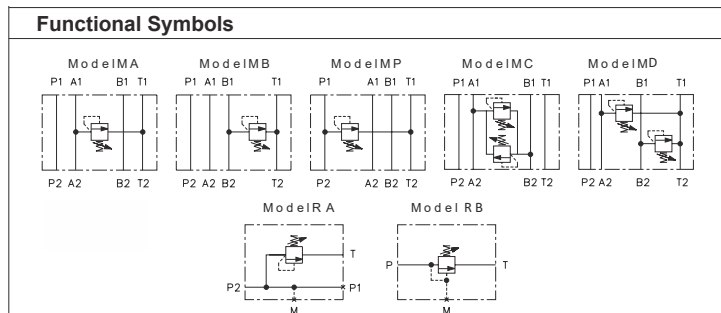

CETOP 3 PILOT OPERATED CHECK VALVE :

The 2RJV1-06 valve is a pilot operated check valve in a sandwich plate design used to give leak free closure of one or two actuator ports under pressure, even during long idle periods. These valves are used in valve stacks

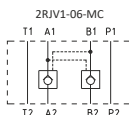
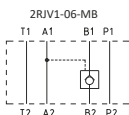
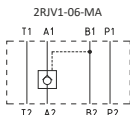
ARGO
HYTOS

BODY TYPES	MAX FLOW (L/MIN)	MAX PRESSURE (BAR)
2RJV1-06-MA	60	320
2RJV1-06-MB	60	320
2RJV1-06-MC	60	320

CETOP 3 DOUBLE THROTTLE CHECK VALVE :

The 2VS3 valve is a double throttle valve and is used to control flow rates in two separate lines (A, B) in a hydraulic circuit. The modular design provides six functional symbols. The throttle valve is built into channel A or B or into channels A and B. The valve restricts the fluid flow in one direction while providing reverse free-flow in the opposite direction.

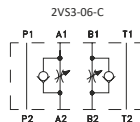
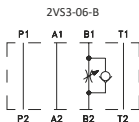
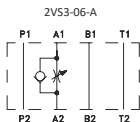

BODY TYPES	MAX FLOW (L/MIN)	MAX PRESSURE (BAR)
2VS3-06-A	80	320
2VS3-06-B	80	320
2VS3-06-C	80	320

CETOP 3 PILOT OPERATED CHECK VALVE :

ARGO
HYTOS

The 2RJV1-06 valve is a pilot operated check valve in a sandwich plate design used to give leak free closure of one or two actuator ports under pressure, even during long idle periods. These valves are used in valve stacks

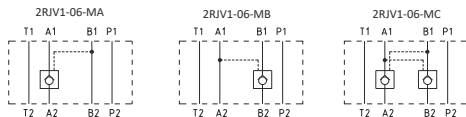

BODY TYPES	MAX FLOW (L/MIN)	MAX PRESSURE (BAR)
2RJV1-06-MA	60	320
2RJV1-06-MB	60	320
2RJV1-06-MC	60	320

CETOP 3 DOUBLE THROTTLE CHECK VALVE :

The 2VS3 valve is a double throttle valve and is used to control flow rates in two separate lines (A, B) in a hydraulic circuit. The modular design provides six functional symbols. The throttle valve is built into channel A or B or into channels A and B. The valve restricts the fluid flow in one direction while providing reverse free-flow in the opposite direction.

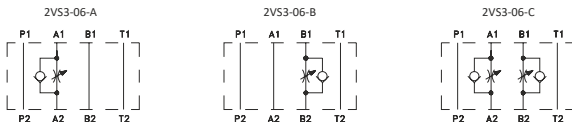

BODY TYPES	MAX FLOW (L/MIN)	MAX PRESSURE (BAR)
2VS3-06-A	80	320
2VS3-06-B	80	320
2VS3-06-C	80	320

CETOP 3 STANDARD MANIFOLDS :

The DR2-06 range are standard CETOP 3 manifolds with built in relief valves

ARGO
HYTOS

NUMBER OF STATIONS	MAX FLOW (L/MIN)	MAX PRESSURE (BAR)
DR1-06/11	80	(AL) 320 (ST) 350
DR1-06/21	80	(AL) 320 (ST) 350
DR1-06/31	80	(AL) 320 (ST) 350
DR1-06/41	80	(AL) 320 (ST) 350
DR1-06/51	80	(AL) 320 (ST) 350
DR1-06/61	80	(AL) 320 (ST) 350
DR1-06/71	80	(AL) 320 (ST) 350
DR1-06/81	80	(AL) 320 (ST) 350

CETOP 3 STANDARD SUBPLATES :

The DP3-06 range are standard CETOP 3 subplates made

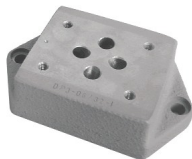

BODY TYPES	CONNECTION (BSP)	MAX PRESSURE (BAR)
DP3-06/32-7	1/4"	350
DP3-06/32-8	3/8"	350
DP3-06/32-9	1/2"	350

SUCTION FILTER :

This filter is used in the suction line of pumps in hydraulic or lubricating circuits.

They offer protection against coarse dirt particles that have remained in the system after manufacture

ARGO
HYTOS

PART NO	CONNECTION (BSP)	MAX FLOW (L/MIN)	FILTER FINENESS
AS 010 - 00	1/2"	15	100
AS 025 - 01	3/4"	35	100
AS 040 - 01	1"	60	100
AS 060 - 01	1-1/4"	90	100
AS 080 - 01	1-1/2"	120	100
AS 100 - 01	2"	200	100
AS 150 - 01	2-1/2"	350	100

D 043 RETURN LINE FILTER :

This filter is used in the return line of hydraulic systems. Protection against wear by means of filter elements that, in full-flow filtration meet even the highest demands regarding cleanliness classes.

By means of full-flow filtration in the system return, the pumps above all are protected from dirt particles remaining in the system after assembly.



C	L	M	N	O	P	Q	R
62	88	9	50	11	45	9.5	75.5

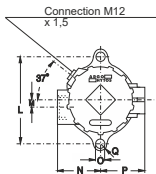

Required mounting

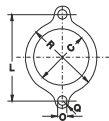

PART NO	CONNECTION (BSP)	MAX FLOW (L/MIN)	FILTER FINENESS
D 043 - 106	1/2"	15	100
D 043 - 88	1/2"	35	100
D 043 - 73	1/2"	60	100
D 043 - 05	1/2"	90	100
D 043 - 10	1/2"	120	100

LIST PRICE

RETURN LINE FILTER :

This filter is used in the return line of hydraulic systems. Protection against wear by means of filter elements that in full-flow filtration meet even the highest demands regarding cleanliness classes.

By means of full-flow filtration in the system return, the pumps above all are protected from dirt particles remaining in the system after assembly.

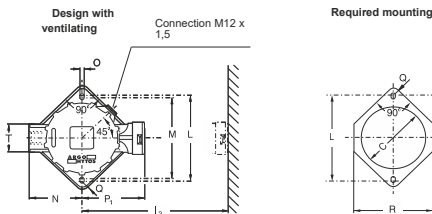
ARGO
HYTOS

C	L	M	N	O	Q	R	P1	I2
90	115	110	70	11	13.5	107.5	82	125

PART NO	CONNECTION (BSP)	MAX FLOW (L/MIN)	FILTER FINENESS
E 094 - 661	3/4"	50	30
E 103 - 657	1/2"	45	5
E 103 - 676	3/4"	80	10
E 103 - 898	1"	110	16
E 103 - 871	3/4"	70	30
E 143 - 657	3/4"	70	5
E 143 - 676	1"	115	10
E 143 - 888	1"	135	16
E 143 - 851	1"	120	30

RETURN LINE FILTER :

This filter is used in the return line of hydraulic systems. Protection against wear by means of filter elements that in full-flow filtration meet even the highest demands regarding cleanliness classes. By means of full-flow filtration in the system return, the pumps above all are protected from dirt particles remaining in the system after assembly, repairs, or which are generated by wear or enter the system from outside.

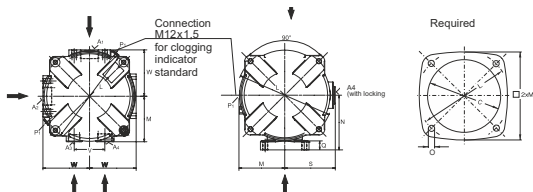
ARGO
HYTOS

C	L	M	N	O	Q	S	V	W
180	220	104	125	11.5	20	115	70	106

PART NO	CONNECTION (BSP)	MAX FLOW (L/MIN)	FILTER FINENESS
E 303 - 453	2x G1-1/4" / SAE1-1/2" / 3/4" + 1"	220	30
E 303 - 456	2x G1-1/4" / SAE1-1/2" / 3/4" + 1"	350	5
E 303 - 458	2x G1-1/4" / SAE1-1/2" / 3/4" + 1"	500	10
E 503 - 453	2x G1-1/4" / SAE1-1/2" / 3/4" + 1"	350	16
E 503 - 456	2x G1-1/4" / SAE1-1/2" / 3/4" + 1"	540	30
E 503 - 458	2x G1-1/4" / SAE1-1/2" / 3/4" + 1"	750	5
E 703 - 453	2x G1-1/4" / SAE1-1/2" / 3/4" + 1"	500	10
E 703 - 456	2x G1-1/4" / SAE1-1/2" / 3/4" + 1"	740	16
E 703 - 458	2x G1-1/4" / SAE1-1/2" / 3/4" + 1"	900	30

PRESSURE LINE FILTER :



This filter is used in the pressure line of hydraulic systems. Protection against wear by means of filter elements that, in full-flow filtration meet even the highest demands regarding cleanliness classes. By means of full-flow filtration in the system, through installation near to control valves or other expensive components. These are protected from dirt particles remaining in the system after assembly, repairs, or which are generated by wear or enter the system from outside.



PART NO	CONNECTION (BSP)	MAX FLOW (L/MIN)	FILTER FINENESS
HD 049 - 179	1/2"	27	5
HD 049 - 176	1/2"	50	10
HD 049 - 178	1/2"	75	16
HD 049 - 161	1/2"	55	30
HD 069 - 179	1/2"	60	5
HD 069 - 176	3/4"	85	10
HD 069 - 178	3/4"	105	16
HD 069 - 161	3/4"	80	30

PRESSURE LINE FILTER :

This filter is used in the pressure line of hydraulic systems. Protection against wear by means of filter elements that, in full-flow filtration meet even the highest demands regarding cleanliness classes. By means of full-flow filtration in the system, through installation near to control valves or other expensive components. These are protected from dirt particles remaining in the system after assembly, repairs, or which are generated by wear or enter the system from outside.



PART NO	CONNECTION (BSP)	MAX FLOW (L/MIN)	FILTER FINENESS
HD 319 - 279	1 1/4"	155	5
HD 319 - 276	1 1/4"	250	10
HD 319 -278	1 1/4"	330	16
HD 419 - 279	1 1/4"	190	5
HD 419 - 276	1 1/4"	330	10
HD 419 - 278	1 1/4"	380	16
HD 619 - 279	1 1/2"	280	5
HD 619 - 276	1 1/2"	400	10
HD 619 - 278	1 1/2"	450	16

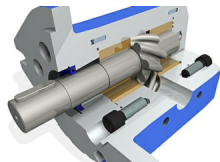

Continuum® pump is the right answer to avoid all problems due to system pulsation. The special design of the internal rotors eliminates any cavitation and any pulsation, driving to no noise, long life of the pump and the systems and energy loss reduction.

Models	28 - 33 - 38 - 47 - 55 - 72 - 92* - 106*
Flanges	Group 1 – Group 2 (European, German, BKT, SAE-A) – Group 3 (European, SAE-B) – Group 4 (SAE-D)
Connections	BSPP (GAS) – SAE 3000/6000 PSI – FL 4 HOLES M6 SU Ø40 DN20 (mentioned connections depend on model)
Installation position	External and/or under oil
Shaft rotation	Clockwise (please contact for counter clockwise)
Shaft speed	From 150 to 6.500 rpm (for usage below 1.000 rpm or over 1.800 rpm please contact)
Flows	From 4 up to 220 cm ³ – from 6L/min up to 330L/min (at 1.500 rpm)
Operating pressure	Max. Continuous: 275 bar Depending on models Max. Cycle ON/OFF: 280 bar Depending on models Max. Peak: 300 bar Depending on models
Inlet pressure	0,8 – 3 bar (depends on models) 0,8 – 3 bar (in base al modello)
Viscosity	Possible: from 5 up to 800 cSt** Recommended: from 32 up to 150 cSt Starting condition: up to 3.000 cSt**
Environmental temperature	From -15°C up to +60°C
Oil temperature	From -15°C up to +80°C***
Contamination level	Up to 8 NAS (18/17/14 ISO4406) (for heavy duty operations over 150 bar, over 4 working hours/day, 100 cycle/day oil ISO 46)
Filtration	From 25 to 10 µm (for heavy duty operations over 150 bar, over 4 working hours/day, 100 cycle/day oil ISO 46)
Seals	NBR, FKM (others on request)
Acoustic emissions	From 52 up to 63 db(A) at 2.950 rpm
Flanges material	Cast iron

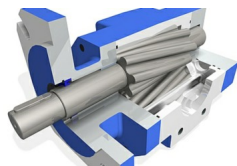

2VHL Continuum® Pumps are transfer pumps designed to handle a wide variety of fluids, with no operating noise. The rotors of 2VHL Continuum® Pumps have been designed using the well known Continuum® helical rotors, which are a byword for **silence, energy consumption reduction and high performance.**

Characteristics	Unit	Minimum	Maximum
Gas content (undissolved)	Vol. %	0	10
Level of contamination	ISO4406	0	21/19/17
Kinematic viscosity	mm ² /s	7	100.000*
Temperature (NBR seals)	°C	-25	80
Temperature (FPM seals)	°C	-25	150
Acoustic emissions	db(A)	52 @ 1500 rpm	63 @ 2950 rpm
Pressure	bar	0	25 (peak: 40)

Type	Class	Nominal CC	Flange & Shaft	Ports	Seals & Rotation	Rotation	Ext. Adjustable Safety Valve	Corrosion & Preservation
GR47	2VHL	28	F80IAC	M	Standard NBR - none	Standard Clockwise - DX	Standard - none	Standard Phosphating - none
		32						
		40			Optional FKM - V	Optional Anti-Clockwise - SX	Optional - RP	Optional Varnishing - VA
		50						
63								

Type	Class	Nominal CC	Flange & Shaft	Ports	Seals & Rotation	Rotation	Ext. Adjustable Safety Valve	Corrosion & Preservation
GR55	2VHL	75	F110EAC	M	Standard NBR - none	Standard Clockwise - DX	Standard - none	Standard Phosphating - none
		91						
		101			Optional FKM - V	Optional Anti-Clockwise - SX	Optional - RP	Optional Varnishing - VA
		125						
		160						

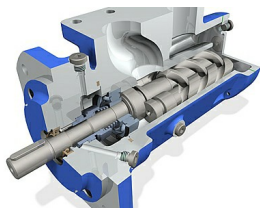

In the SFO pumps, the fluid has a uniform axial flow which leads to a minimum of fluid pulsation and an extremely quiet operation. The SFO pump has been designed for handling non-aggressive fluids with sufficient lubricating properties.

Models	25 - 32 - 40
Drive loading	No axial or radial loads
Shaft rotation	Clockwise (from shaft end)
Shaft speed	From 500 to 3.600 rpm*
Flows	From 12 up to 75 L/min (at 1.450 rpm)
Outlet pressure	20 bar continuous - 40 bar intermittent
Inlet pressure	Min. -0.7 bar max. 1.5 bar (for higher pressure please contact)
Fluids	Mineral oil, synthetic oil, oil water emulsions, fuels, marine distillate fuels, marine residual fuels
Viscosity	**Down to 2 cSt
Seals	Lip seal: NBR, Viton, EPDM (others on request) Mechanical seal Lip seal + Mechanical seal
Acoustic emissions	From 50 up to 58 db(A) at 2.950 rpm
Pump body	Cast iron GJL-250 EN 1561
Screw	Steel (central steel, lateral cast iron on request)
Environment temperature	From -20°C up to +50°C
Hydraulic temperature	From -20°C up to +155°C
Filtration	Permitted 70 µm, (in case of low viscosity 20 µm)

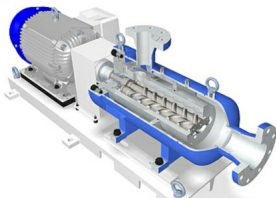

SMAPI pumps are three screw pumps API676 (3rd edition) compliant.

Models	20 - 25 - 32 - 40 - 45 - 55 - 60 - 70 - 80 - 90 - 110 - 125 - 150 - 180
Installation	Vertical, horizontal
Connections	SAE, DIN, ANSI
Drive loading	No axial or radial loads
Shaft rotation	Clockwise (from shaft end) , (suitable also for counter clockwise rotation, please contact)
Shaft speed	From 300 to 3.600 rpm
Flows	From 4 up to 1.800 L/min (at 2.950 rpm) -From 1.800 to 3.200 L/min pump must be over-busted, contact Trident
Outlet pressure	60 bar continuous – 80 bar intermittent
Inlet pressure	Min. -0.7 bar max 9 bar (with mechanical seal)
Fluids	- Mineral oil HLP e HVLP - Ecologic fluids HETG, HEPG, HEE - Synthetic fluid or emulsion: HFA oil-water emulsion, HFB water-oil emulsion 40% of volume, HFC water/glycole – water max 35 to 55%, HFDR phosphate ester - Lubrication high viscosity oils - Special synthetic fluid: MIL-H, SKYDROL - Fuel oil: MGO, MDO, Low sulfur MDO and HFO - DMX (ISO8217), DMA, DMB, DMC, DMZ - MAZUT, bunker oil, furnace oil, engines oil, heating oil, hydraulics oils DIN 51524 - Naphta, petrol
Viscosity	From 2 up to 10.000 cSt
API Seals	Mechanical seal: non-API, API 682, single and double. Mechanical seal flushing system (optional) according to API PLAN 53B. Magnetic coupling available. Seal polymer materials: NBR, FKM, FPM, EPDM
Acoustic emissions	From 52 up to 68 db(A) at 2.950 rpm
External case	ASME carbon steel, inox
Cartridge	Aluminum, cast iron, steel
Screws	Steel for main screw , idler cast iron
Environment temperature	From -20° up to +60°C
Hydraulic Temperature	From -20°C up to +180°C

SMT/SMAT 16B



SMT/SMAT 8B

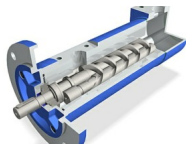

SMT/SMAT

SMT16B are three screw pumps for industrial use at low and medium pressure (40 bar). SMT16B pumps represent a reliable and low noise component for many industrial applications where long life pump and low cost are required. The pump body and the design of the screws avoids any axial load. The functional pressure develops some tolerance between the balancing piston of the main screw and the surrounding body. This creates a balancing hydrodynamic force of the screws and, at the same time, lubricates and cools down the sealing parts.

SMT8B series are three screw pumps ideal for heavy duty cooling and chilling applications. The extremely compact design enables to use this pump also in applications where there is no space for traditional screw pumps. SMT8B pumps are very often used for gear box lubrication, hydro power, jacking oil systems in the wind energy, industrial and mobile sectors.

SMT Pumps are three screw pumps for industrial use at low and medium pressure (40 bar). SMT pumps represent a reliable and low noise component for many industrial applications where long life pump and low cost are required. The pump body and the design of the screws avoids any axial load. The functional pressure develops some tolerance between the balancing piston of the main screw and the surrounding body. This creates a balancing hydrodynamic force of the screws and, at the same time, lubricates and cools down the sealing parts.

Types	Dry (SMT) or submerged (SMIT)
Models	20 – 25 – 32 – 40 – 45 – 55 – 60 – 70 – 80 - 90 (SMT16B) - 110 - 125 - 150 - 180
Installation	Free for SMT. Submerged (totally or partially) for SMIT (SMT16B) - Foot Mounted 125 and UP
Flanges	ISO 3019/2
Connections	SAE 3000 - BSPP
Drive loading	No axial or radial loads
Shaft rotation	Clockwise (from shaft end) , (suitable also for counter clockwise rotation Contact Trident)
Shaft speed	From 500 to 3.600 rpm(1)
Flows	From 4 up to 1.220 L/min - SMT16B - From 4 up to 3,200L/min (model 20 to 110)
Outlet Pressure	Up to 80 bar (SMT16B) - Up to 40 Bar
Inlet Pressure	Min. -0.7 bar max. 3 bar
Fluids	Mineral oil HLP e HVLP Ecologic fluids HETG, HEPG, HEE Synthetic fluid or emulsion: HFA oil-water emulsion, HFB water-oil emulsion 40% of volume, HFC water/ glycole – water max 35 to 55%, HFDR phosphate ester Lubrication high viscosity oils Special synthetic fluid: MIL-H, SKYDROL, Fuel oil: MGO, MDO, Low sulfur MDO and HFO DMX (ISO8217), DMA, DMB, DMC, DMZ Bunker oil, furnace oil, engines oil, heating oil, hydraulics oils DIN 51524
Viscosity	From 2 up to 10.000 cSt
Seals polymer	NBR, FKM, EPDM
Seal type	TM, TMK, TMZ, FGM
Acoustic Emissions	From 52 up to 68 db(A) at 2.950 rpm (value based on ISO 4412 test procedure)
Pump body	Cast iron, steel. Hardened steel and stainless steel available on request.
Screws	Core hardened steel screws, surface treated screws
Environment temp	From -50° up to +60°C (SMT16B - From -50° up to +60°C)
Hydraulic temp	From -50°C up to +300°C
Filteration	Permissible degree of fluid contamination NAS to 1638 class 10 or ISO DIS 4406 – 19/16. Recommended filtration $\beta_{25} \geq 75$

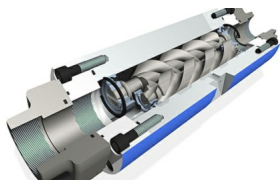

The Settima flow rate transmitter is especially designed for the metering of viscous fluids. The unit works volumetrically according to the principle of screw transmitters highly accurate and independent of viscosity.

The medium passes a defined admission bore to get into the flow chamber and causes the revolution of the two screws mounted here. The revolutions are detected by a magnetically biased Hall sensor outside the flow chamber. Additional magnets in the flow chamber are not required. The volumetric function of the unit causes an operation independent of viscosity up to 40.000 cSt.

TYPE	FL32	FL40	FL55	FL70	FL80
Q _{nom} (L/min)	140	350	800	1500	2500
Q _{max} (L/min)	200	500	1200	2200	3800
cc	26	58	144	266	478
BSPP port	1"	1 1/4"	1 1/2"	2"	2 1/2"
SAE6000 port	1"	1 1/4"	1 1/2"	2"	2 1/2"
RPM max (3)	7.6	8.6	8.6	8.2	8
Pulse / Liter	76	34	14	8	4
Sensor frequency (Hz)	254	287	278	275	265

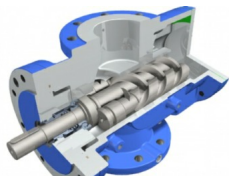

SLN three screw pumps are designed to avoid any pulsation to ensure a smooth operation and to reduce to the lowest level the acoustic emissions, reducing all costs of second noise reduction measures. The pulsation-free flow of SLN pumps allows Settima screw pumps also in output condition management critical to applications such as precision hydraulic controls and fuel metering. SLN pump can be equipped with a magnetic coupling if required.

Types	Dry or submerged
Models	20 - 25 - 32 - 40 - 45 - 55 - 60 - 70
Installation	Free or submerged (totally or partially)
Flanges	ISO 3019/2
Connections	ISO 7500 PN 16/40
Drive loading	No axial or radial loads
Shaft rotation	Clockwise (from shaft end) , (suitable also for counter clockwise rotation)
Flows	From 4 up to 800 L/min
Outlet Pressure	Up to 40 bar
Inlet Pressure	Min. -0.7 bar max. 3 bar(2)
Fluids	Mineral oil HLP e HLVP - Ecologic fluids HETG, HEPG, HEE - Synthetic fluid or emulsion: HFA oil-water emulsion, HFB water-oil emulsion 40% of volume, HFC water/ glycole – water max 35 to 55%, HFDR phosphate ester - Lubrication high viscosity oils - Special synthetic fluid: MIL-H, SKYDROL, - Fuel oil: MGO, MDO, Low sulfur MDO and HFO - DMX (ISO8217), DMA, DMB, DMC, DMZ - Bunker oil, furnace oil, engines oil, heating oil, hydraulics oils DIN 51524
Viscosity	From 1 up to 10.000 cSt
Seals polymer (shaft, O-ring)	NBR, FKM, EPDM
Seal type	TM, TMK, TMZ, FGM
Acoustic Emissions	From 52 up to 68 db(A) at 2.950 rpm value based on ISO 4412 test procedure
Pump body (special applications)	Cast iron, steel. Hardened steel and stainless steel available on request (Contact Trident)
Screws (special applications)	Core hardened steel screws, surface treated screws
Environment Temperature	From - 50 ° up to + 100°C (6)
Hydraulic Temperature	From - 50° C up to + 300° C (6)
Filtration	Permissible degree of fluid contamination NAS to 1638 class 10 or ISO DIS 4406 – 19/16. Recommended filtration $\beta_{25} \geq 75$

SPECIALISTS IN

- Hydraulic Pump and Motor Repairs / Replacements
- Ultra High Pressure Interlock Hose and Fittings
- Ram Repairs / Replacements
- Power Steering Hoses and Pipes
- Micro Bore Hoses
- Cold Store Hoses
- Filters and Offline Oil Filtration Units
- Oil and Lubricants
- Mobile Oil Contamination Testing
- Pressure and Flow Testing
- Power Pack Servicing
- Tube Manipulation
- Belts, Drives and Couplings
- Oil Spill Products and Accessories
- Hydraulic & Pneumatic Installations
- Tools and Equipment supplies

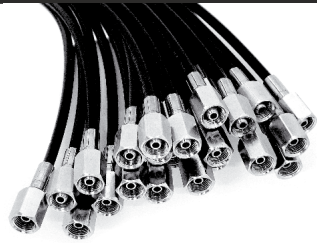

The Trident Hydraulic Generator is a Complete Power Solution Package

Compact, Versatile and Simple to Install

The standard manifold is capable of working with flow rates of up to 60 litres per minute at a max pressure of 200 bar.

By simply changing the gear motor and alternator, it can provide rated outputs up to 20kVa in single or three phase, 50Hz or 60Hz

The manifold incorporates all of the required valves to allow the generator to operate without the need for any other component parts. It incorporates a solenoid operated diverter valve, pressure relief valve and a pressure compensated flow control.

The unit operates only when the solenoid is energised, this then diverts flow away from any other function and through the flow control valve to provide a regulated flow through the gear motor to the alternator. Excess flow is returned to tank.

When the solenoid is de-energised, flow passes directly into P1 and out of P2 which simply acts as a bypass to the generator function.

Electrical connection is extremely simple, a 12V DC or 24V DC supply is required to energise the directional valve which in turn can be connected to a simple toggle switch.



Boom Lift Fitted with Hydraulic Generator for Power Tools and Lighting



Tunnel maintenance unit for the rail industry fitted with 110V Hydraulic Generator for tools and lighting



Mobile Milling Power Units Fitted with Hydraulic Powered Generator for Flood Lighting

- Hydraulic Pump, Motor, Repair and Test Centre
- Pump and motor strip down and repair
- Full failure reporting
- Full test facility using state-of-the-art controls
- Computer software controlled test rig
- Data logging and graphical test reports including efficiency
- Moog, Bosch/Rexroth, Commerical, Voith, KPM, Dowty and Vickers
- Avcat and Diesel test rig
- Value strip down, repair and test
- Contamination reporting and control
- Site removal, install and commissioning

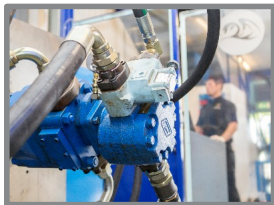
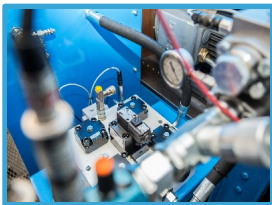
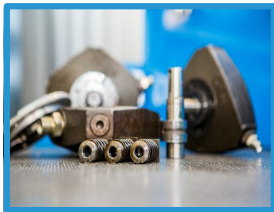
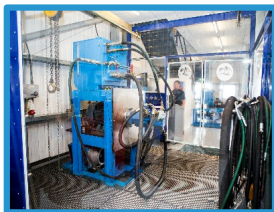



Chain testing panel with full PLC Control and programmable



Milling machine control panel



Oil and Gas Test Panel

LET'S GO
DESIGN 

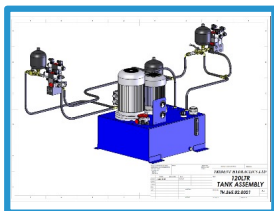
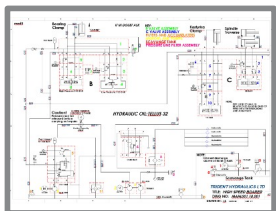
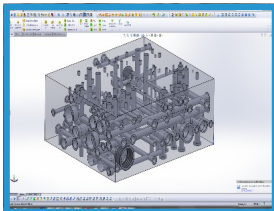

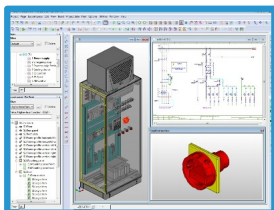
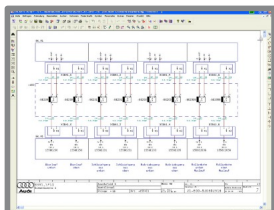
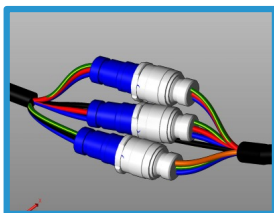
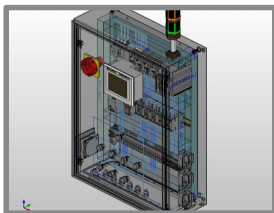

2D —————> 3D

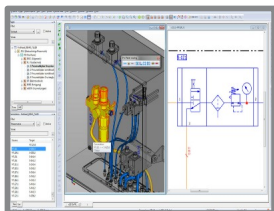

The Power in Engineering

TRIDENT

HYDRAULICS & ELECTRONICS



Hydraulic Pump & Motor
Test Repair Centre



Mobile Power Units



Industrial Power Units



Large Production
Runs



Innovation & Technical Design

UNIT 12 HOLYWELL BUSINESS PARK
NORTHFIELD ROAD
SOUTHAM
WARWICKSHIRE
CV47 0FP

TEL : 01926 811 395

FAX : 01926 812 291

EMAIL : info@tridenthydraulics.co.uk

WEB : www.tridenthydraulics.co.uk